

ITEM	PART NO.	VARIANT	QTY	MODEL / DESCRIPTION
①	(4287)	WGB	1	VBV-750M MONITOR KIT
②	(1386)	N/A	1	VBV-L410 10M CAMERA CABLE
③	(2575B)	WGB	1	VBV-701C CAMERA KIT

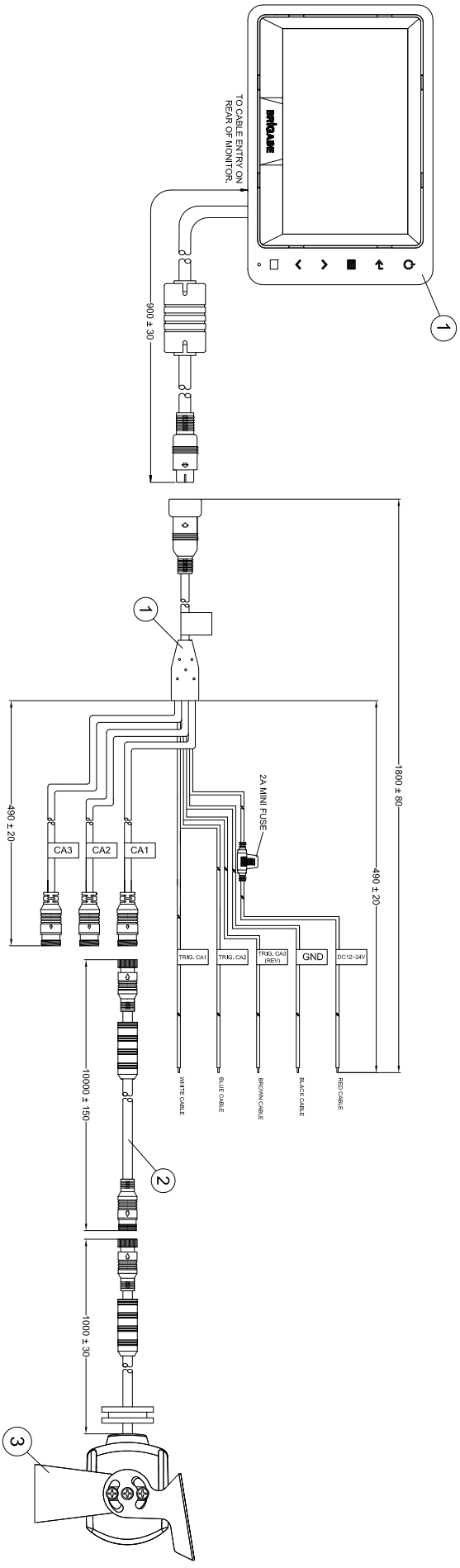

- NOTES:
1. REFER TO COMPONENT DRAWINGS FOR COMPONENT DETAIL.
 2. REFER TO COMPONENT PRODUCT SPECIFICATIONS FOR PRODUCT SPECIFICATIONS.
 3. FOR SYSTEM BOX SERIAL NUMBER LABELS REFER TO LATEST REVISION OF DRAWING BE-001323-XX-10.
 4. FOR SYSTEM GIFTBOX LABEL REFER TO LATEST REVISION OF DRAWING BE-002886-XX-14.
 5. PURCHASE ORDER TO DEFINE SYSTEM PACKAGING VARIANT.
 6. REFER TO LATEST REVISION OF DRAWING BE-001954-XX-12 FOR PACKAGING DETAIL.

PROPRIETARY NOTICE
 THIS DESIGN AND TECHNICAL INFORMATION APPEARING ON THIS DRAWING IS THE PROPERTY OF BRIGADE ELECTRONICS, AND IS DISCLOSED IN CONFIDENCE. IT IS NOT TO BE COPIED, REPRODUCED, REVEALED TO OR EXPLOITED BY OTHERS, EITHER IN WHOLE OR IN PART WITHOUT THE EXPRESS WRITTEN CONSENT OF BRIGADE ELECTRONICS.



Angle of Projection 		Assembly PI Approval YILING ZHANG (29/05/14)		Approved by B.JOHN		Checked by RBATES		Drawn by MBUTLER	
Status RELEASED		Scale N/A		Released 29/05/14		Assembly Ref -		VBV-750-010N	
Part No 4707		BE-002891-00-14							